

KONICA MINOLTA

AccurioLabel 190

Full Colour Label Printing System



Giving Shape to Ideas

Just the right size

“Perfect Fit”

Label Printer

“AccurioLabel 190” has been created to take center stage on the globally-expanding digital label market.

Adoption of a production printer as the engine, which represents the culmination of cutting-edge technologies amassed by Konica Minolta over a span of many years. AccurioLabel 190 contributes to business expansion by perfectly balancing customer needs from the perspectives of quality and cost.

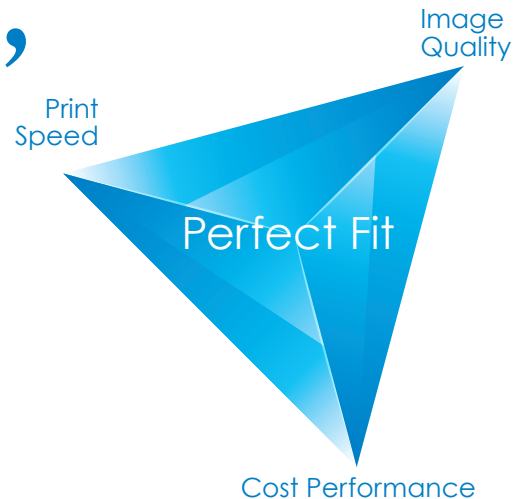

AccurioLabel 190



- High image quality of 1200dpi, close to offset printing
- Productivity at a top class, maximum speed of 13.5m*1 for tack paper
- Space-economical design with a footprint of 5.0m x 3.0m*2
- Ensures facilitation of work during procedures such as maintenance and job changes

*1: Feeding speed needs to be changed depending on the paper type: 18.9, 13.5, 9.45m/min.

*2: System size: approx. 1,100mm (D) x 4,000mm (W)



Digital Label Printer matched to Market Needs

The global label market continues to expand by the day with the prospect of further stable growth in the future. The ratio of demand for digital labels is increasing year by year, giving rise to a trend of growing demand for small-lot printing.

Why digitize Label Printing?

As the number of high-mix low-volume print jobs continues to increase, print companies now find themselves in a position where they also need to be able to cope with orders with shorter lead times than with conventional high-volume printing.

Printing demands that were difficult to cope with using analogue printers can now be handled efficiently thanks to the flexibility that is one of the advantages of digital printing. The added value that digital printers provides for tasks such as variable and numbering printings enables print companies to realize product differentiation amidst diversifying market needs.



Problems with analog machines

Settings such as color tone adjustments and ink cleaning are required.

- 1 Preparatory time for exchange of printing plate, etc. is necessary for each job.
- 2 A significant amount of roll paper is wasted by tasks such as trial printing.
- 3 Expert knowledge and proficiency are required.

Merits of digital machines

Data is output directly from a PC.

- 1 Preparations involve only tasks such as paper replacement and color tone adjustments.
- 2 Stable output is possible from the very beginning of the print job, minimizing paper waste.
- 3 Tasks such as output instructions and maintenance can also be performed by following on-screen instructions.

“AccurioLabel 190” a digital label printer that offers outstanding productivity, image quality, operability and economy, is a **“Perfect Fit”** for new market expansion and parallel use with existing analog machines.

Users to whom AccurioLabel 190 is recommended



Small to Middle Volume

Small to medium-size label and seal print companies who take on orders for local brand work

Target Applications

Food and beverage products (e.g. event-related goods, souvenirs such as local wines, jams, ham and cheeses), cosmetics, beverages (small lots for events), local household detergents that use packaging film, and so on.

Applications realized by AccurioLabel 190 to meet a wide range of diversifying needs

Gradations

Abundance of gradation expressions to achieve a natural finish.



Photographic image quality

Realization of stable, high image quality by multi-gradation data processing and an expansive color gamut.

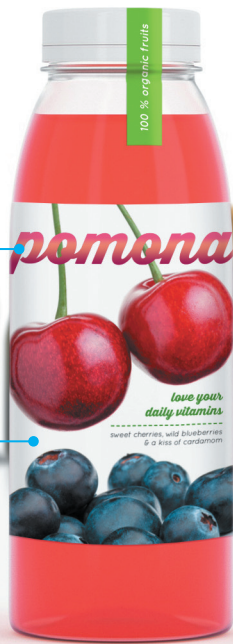

Thin-line expression

Thin lines in complex line images are also faithfully reproduced at a high resolution of 1200dpi.



Variable printing

Content can be changed for each sheet, effective for lot number changes or creation of original labels, for example.



Small-point characters

Small characters are also vividly printed to ensure ease of reading.



Barcode printing

Small barcodes can also be printed without blurring. Variable barcodes can also be printed.



Reproduction of skin tones

Roughness of the skin can be suppressed to reproduce richly-textured human skin tones.



Solid density

Solid black areas with high image density can be expressed with a suitable glossy appearance.

From sample to production printings in the small to medium-volume label market

Liquors



For locally produced wine, beer, sake, etc.

Beverages



For PET beverage bottles for events, meetings, etc.

Food

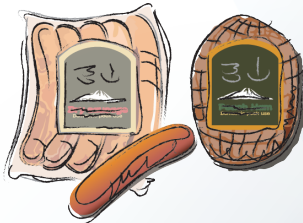

For locally produced jams, sausages, hams, cheeses, etc.

Household products



For private brand samples, local brand products, etc.

Industrial Products

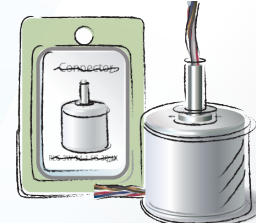

For GHS labels for specified chemicals, name plates for limited-quantity products, etc.

Cosmetics



For cosmetics samples, private brand products, local brand products, etc.

Medicines



For medical drugs, prescription drugs, etc.

Label substrates

- **Glossy or matte art paper**

Food (locally produced jams, sausages, etc.), beverages (wine, sake) and sundry goods (event goods, mementos, etc.)

- **YUPO®, PET, PP, etc.**

For cosmetics, medical drugs, industrial products, beverages.

Small to medium volume market

The toners of AccurioLabel 190 are in compliance with FDA standards by the evaluation of the authorized organization considering the safety of indirect food packaging label.

*The FDA standard is stringent safety standards to the potential product that consumers are in contact with food, pharmaceutical and cosmetic by FDA (Food and Drug Administration).

Achieves both High Image Quality and Productivity through

High Image quality and High-precision Printing

► Multi-gradation Data Processing at a high Resolution of 1200dpi x 8bit

High resolution of 1200dpi produces a high-precision finish. Combined with the reproductive capability of digital toner HD^E, small characters and fine lines can be printed clearly and color images beautifully output in rich gradations.



• 8bit/256-gradation processing

Color and monochrome are processed at a resolution of 1200dpi x 8bit with 256 gradations expressed in 1 pixel.

• “S.E.A.D.” – Image Processing Technology to meet Sophisticated Needs

Furnished with an even more evolved “S.E.A.D.” – Konica Minolta’s unique image processing technology. High-precision image processing is performed in close linkage with the image formation process, achieving a high-dimensional fusion of “productivity,” “image quality” and “stability” and producing high image quality by taking optimum advantage of the engine characteristics.



High Printing Speed

► Realization of production speed 13.5m/min for tack paper

Furnished with the top level speed and stable printing performance in the class, per-minute speeds of 18.9m, 13.5m and 9.45m are selected depending on the paper type. In addition, the fast startup after switching on the power enables reduction in setup time, enhancing output productivity.



Ex) 8-up labels on A4 sheet ▶ capable to print 10,000 labels(263m) in approx. 25min(13.5m/min).

Outstanding Operability and Maintainability

► Ease of Tasks such as Color Adjustments and Reprinting compared to Analog Machines

Compared not only to flexography, but also liquid development and inkjet printers, AccurioLabel 190 ensures ease of maintenance. Tasks that take time on analog machines such as color adjustments can be performed with ease on a digital machine. The ability to perform operations simply by following on-screen instructions makes it possible to operate the machine with little time needed for training.



• Mouse-compatible Operation Panel

The large 15-inch display adopted is easy to view and operate. The angle of the panel can be freely adjusted to suit the user and the easy-to-understand GUI and guide messages ensure high operability when making settings. A USB mouse can also be connected to improve operability.

POINT

Clear Print Quality

Furnished with a precise outline processing function that reduces blurring and streaking to realize high quality even for color or outline characters. Characters on food or ingredients labels, for example that tend to be small, or barcodes can be printed clearly.

Without line-thinning process

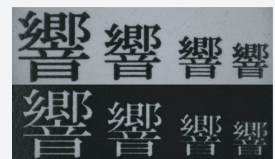

With line-thinning process

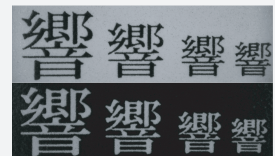

POINT

Major Improvement in Production Efficiency

Digital printing requires no plate making, making it possible to improve the efficiency of the integrated flow from file reception to printing. In addition, high flexibility in designing and ease of color control enable to handle reprinting of previously-output labels with speed. The ability to print no more than required volumes when needed also keeps inventory to a minimum.



POINT

Compact System Size

Compared not only to analog printers, but also other digital printers of the same standard, the system offers the advantages of compact size. The space-economical design eliminates worries over the place of installation and makes it possible to increase work space.



System size: Approx. 1.1m (D) x Approx. 4.0m (W)
Space occupied: Approx. 3.0m (D) x Approx. 5.0m (W)

our cutting-edge Digital Printing Technologies

High Media Compatibility

► Allows use of labels in various scenes

Furnished with newly-developed digital toner HD^F to further improve image quality and energy-saving performance. The 3-dimensional hybrid structure that incorporates functional polymers provides high contouring performance for all types of media, enabling realization of ideal natural textures. In addition, fixation at lower temperatures contributes to major reductions in power consumption.

• Toner particles with a 3-dimensional hybrid structure

Colorant

Improved red-gamut color reproduction and color-fading resistance. In addition, improved granularity enhances half-tone and skin tone quality.

Functional polymer

Produces high image quality, improves energy-saving performance and enables high-speed processing.

Sharp melt wax

Contributes to high image quality and improved energy-saving performance.

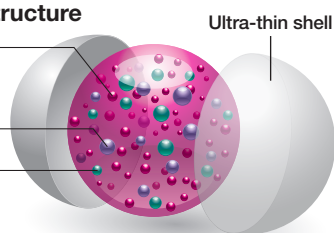

• Blue Wool Test: The results according to ISO 105 B2 (lightfastness test).

● Cyan 8*1	● Yellow 8	Remarks: The evaluation criteria is classified into 8 levels (1 to 8 levels), and the higher the value, the higher the lightfastness. *1 The test results indicate that the lightfastness of Cyan and Black toner is ranked as 8 or higher.
● Magenta 6-7	● Black 8*1	

Continuous Banner Size Printing

► Capable of continuous printing of a maximum size of 1,195 x 320mm

The system is capable of continuous printing of sizes of a maximum length of 1,195mm and width of 320mm. The advantages of printing 1,195mm lengths enable not only printing of long panels, but also efficient imposition and printing of labels of differing sizes, realizing effective use of paper.



No need for printing plate

► Provides flexibility for high-mix low-volume jobs at low cost

AccurioLabel 190 requires no plate that is essential for analog label printing machines and achieves reduction of paper waste generated during trial printing due to stable and precise output from the beginning of print job. In addition, reduction in labor cost thanks to a digital workflow realizes reduction in production cost compared to analog label printing machines for small-to-medium lots.

Compared to analog machines ...

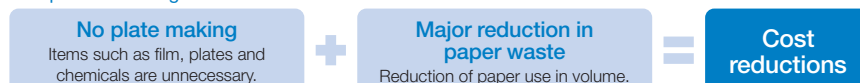

POINT Fixing capability with high reliability

Thanks to digital toner HD^F and Konica Minolta's low-temperature fixation technology, AccurioLabel 190 is compatible with a wide range of media including not only ordinary and matte paper, but also glossy paper, tack paper and film essential for label production. The user can not only select the ideal media to match applications but also print labels without the need for preprocessing.

*Some media types are incompatible.

POINT Wider print application thanks to the banner print capability

As well as store decoration and floor POP displays, the system can be used for long posters, signboards and an extensive range of other applications. The ability to offer promotional proposals with media mixes combined with labels also contributes to business expansion.

POINT Reduction in Total Time

High-mix jobs such as printing information including items and control numbers on chemical product labels, for example. With analog machines, plates need to be changed frequently, resulting in reduced operating ratio and restricting the number of items produced. Digital machines, on the other hand, allow frequent job switchover, offer reduced work time and enhance the ability to meet required delivery time.

• Comparison of Work Time in Analog and Digital Machines

Analog machine	Job A	Job B	Job C	Job D	
Digital machine	Job A	Job B	Job C	Job D	Job E

Reduction in work time + α

■ Setting ■ Job printing

Main Specifications of AccurioLabel 190

Technical specifications

Print method	Dry-toner electrophotography
Color support	Full color (CMYK)
Printing resolution / gradation	1200dpi (3600dpi equivalent) x 1200dpi / 8bit
Max. printing image size	480 x 320mm at normal mode, 1195 x 320mm at banner mode
Paper width	330mm
Printed image width	Max. 320mm (maximum image quality-guaranteed width: 297mm)
Max. unwinder / rewinder diameter	φ500mm
Paper thickness range	60 to 250μm
Feeding speed (printing speed)	18.9m/min., 13.5m/min., 9.45m/min. *Speed depends on the paper type (standard speed: 13.5mm)
Compatible file formats	PS, PDF (APPE compatible), 8bitTIFF
VDP file format	PPML, PDF-VT
Printing media *See the list below for details.	Paper: Non-tack paper, tack paper, Film: Tack film (synthetic paper, PP, PET)
Power requirements	Engine: Single phase 200V 22A 50/60Hz Roll feeder/winder: 3-phase, 200V, 4.1kVA 50/60Hz
Operating conditions	Temperature: 10 to 30°C, Humidity: 10 to 80%RH. No condensation. 20%RH gradually decreasing to 10%RH at 10 to 20°C. [Range of guaranteed performance] Temperature: 18 to 23°C, Humidity: 40 to 60%RH

Details of Media

Media *1	Non-tack paper	Tack paper (Peeling paper only.)
Paper	Plain paper	136 to 256gsm
	Gloss coated paper	
	Matte coated paper	
Film	Synthetic paper (YUPO® *3)	136 to 176gsm *2
	PP	136 to 176gsm *2
	PET (Stretched type)	136 to 216gsm *2

*1: Incompatible depending on the media.

*2: Acrylic glue only.

*3: YUPO® is a registered trade mark of Yupo Corporation.

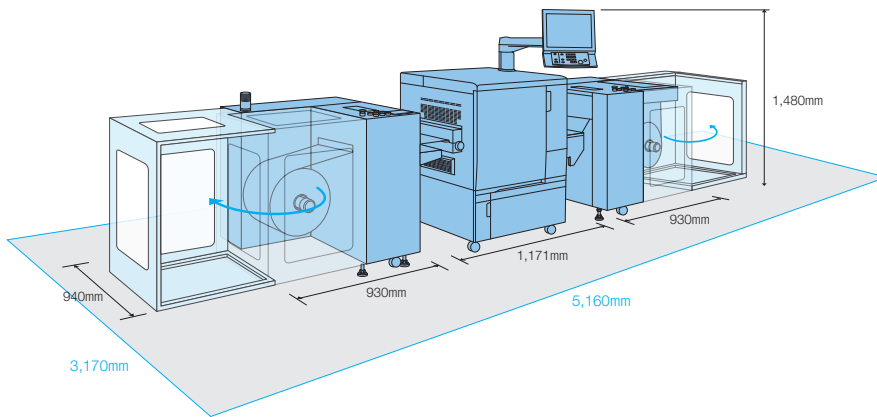

External dimensions, footprint

Dimensions (W x D x H)	Main unit: 1,171 x 903 x 1,480 mm (operation unit included)
	Roll feeder/Roll winder: 930 x 940 x 1,480 mm
Footprint (W x D x H)	5,160 x 3,170 x 1,480 mm (operation unit included)
Weight	Approx. 949kg (approx. 2092lb) (all units included)
	Printer engine: 297kg (approx. 655lb),
	Roll feeder: approx. 320kg (approx. 705lb),
	Roll winder: approx. 332kg (approx. 732lb)

AccurioLabel 190



THE EVOLUTION OF TECHNOLOGY

*1 Optional

Product appearance, configuration and/or specifications are subject to change without notice. This product is not available for some countries or regions.

The KONICA MINOLTA logo, symbol marks, Giving Shape to Ideas, AccurioLabel, Simitri HD[®], S.E.A.D. are registered trademarks or trademarks of KONICA MINOLTA, INC.

All other brands and product names are registered trademarks or trademarks of their respective companies or organisations.



From consulting, system design, to operations, Konica Minolta offers total support to optimise your office output environment.

<http://www.biz.konicaminolta.com/services/ops>

Requirements for safe use

- Please read and follow the instruction manual to ensure safe operation.
- Only operate using appropriate power supply and voltage.
- Connecting the earth wire to an inappropriate place may cause explosion or electric shock. Please connect accordingly (Taiwan and the Philippines only).

Konica Minolta Business Solutions Middle East FZE
P.O. Box 261369
JAFZA Bldg. 22, Jebel Ali Freezone
Dubai, United Arab Emirates
Tel. No. +971 4 880 8388
www.konicaminolta.com/me